

THIS COPY IS PROVIDED ON A RESTRICTED BASIS AND IS NOT TO BE USED IN ANY WAY DETRIMENTAL TO THE INTERESTS OF PANDUIT CORP.

Material	High Conductivity Seamless Copper Tube
Plating	Electro-Tin
Wire Size	4 STR/FLEX (ALL), 3 & 5 FLEX*
Wire Type	Stranded Copper: Class B & C Compact, Class G, H, I, K, M, Locomotive (*Locomotive only)
Wire Strip Length	1-1/8 in.
Stud Size	3/8 in.
UL Listed Wire Connector	Yes, for applications up to 35kv. Consult cable manufacturer for voltage stress relief instructions with applications greater than 2000 volts.
UL Temperature Rating	90° C
C.S.A Certified Wire Connector	Yes
Panduit Color Code on Barrel	GRAY
Panduit Die Index No. on Barrel	P29
Alternate Industry Die Index No. () on Barrel	(8)

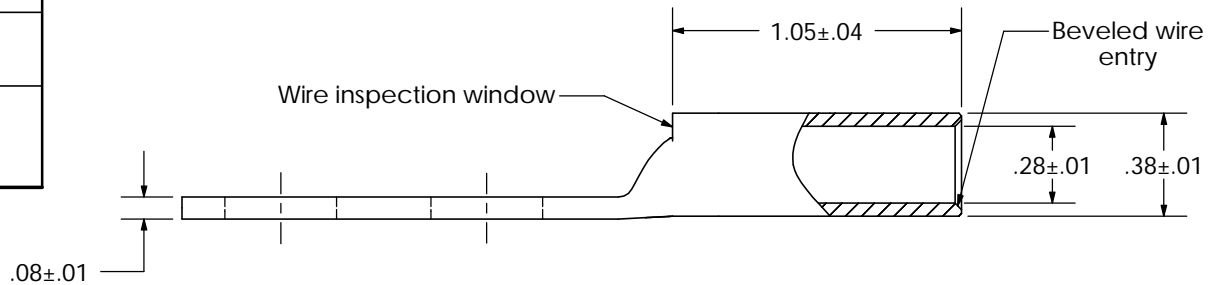

CERTIFIED

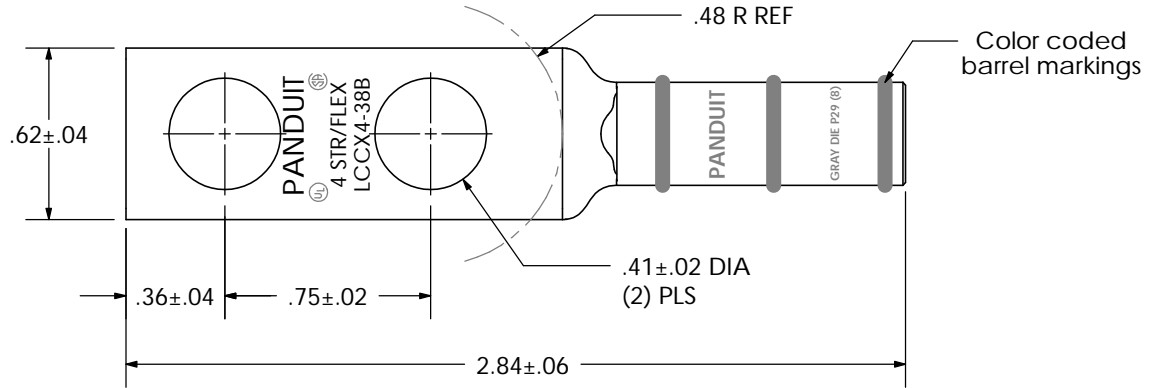

LISTED Wire Connector

03	1/05	JHNU	TLCO	PANDUIT REPLACED WIRE RANGE ON BARREL MARKING	12412
REV	DATE	BY	CHK	DESCRIPTION	ECN

PANDUIT CORP. TINLEY PARK, ILLINOIS

LCCX4-38B-L
Copper Lug - Two-Hole, Long Flex Barrel with Window

SCALE N/A

DRAWING NO / CAD FILE

LCCX4-38B-CUST